



# BEAR ROOTZ

---

## TAO SERIES (DQ11/DQ101S) PACKET QUARTZ AIO'S

---



WE APPRECIATE YOUR BUSINESS & OUR RELATIONSHIP.

# QUARTZ AIO CUSTOMIZATIONS TAO S (DQ11)

## DETAILS

- Patented Quartz Atomizer Technology
- Stainless Steel Center Post
- Rechargeable
- 1.4ohm Resistance
- Micro-USB
- Inhale Activated

## TANK

GLASS

## SIZES

0.3mL 0.5mL 1.0mL

## TIPS (Screw-On)

Shape:

BULLET

Material:

CERAMIC

TIP OPTIONS:  
Black or White  
Ceramic Bullet



## PACKAGING OPTIONS

### INDIVIDUAL OPTIONS

- No Window
- Window
- No Hanger
- Hanger
- Non-CR
- CR

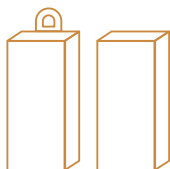

### MASTER DISPLAY

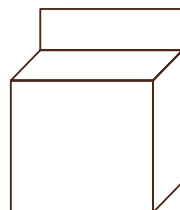

AIO boxes are fully customizable to your brand. We can print as many colors as you would like, but keep in mind, the more colors you print, the higher the cost.

## AIO DESIGN OPTIONS

Options can be combined.

Logo on Body (1 Color)	+ \$0.06
Logo on Body (2 Colors)	+ \$0.11
Logo on Glass (1 Color)	+ \$0.06
Logo on Glass (2 Color)	+ \$0.11
Custom Body Color	+ \$0.11
Custom Color Mouthpiece	+ \$0.11
Cannabis State Warning Symbol on Glass	+ \$0.06-\$0.14

CUSTOM AREAS

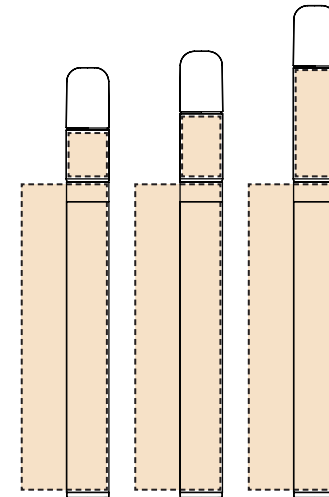

## MINIMUM ORDER QUANTITY

AIO	3,000
INDIVIDUAL BOXES	Varies
MASTER DISPLAY BOXES	Varies

Higher quantities purchased may result in price breaks. Please speak to a sales agent for pricing details.

# TAO (DQT1) QUARTZ AIO



*Same oil, better flavor, happier customers!*

Quartz Atomizer Technology is the next step in the cartridge evolution, it's the most modern & flavorful way to vape! Our Quartz Cartridges feature our patented quartz atomizer and filter system that enhances oil flavor while reducing leakage and damage. Our stock Quartz Cartridges can also be fully customized to suit your branding needs.

## The Best Flavor Profile on the Market

Thanks to the natural properties of quartz, quartz atomizers provide superior flavor and consistent vapor production from the very first puff to the last.

*Atomizers made of non-quartz materials tend to wear down faster, releasing particles into the vapor and altering the oils' natural flavor.*

## Handles Almost All Ranges of Viscosity

Our patented microporous filtering technology allows processors to use a single cartridge style for multiple oil types. Our quartz filters are designed to only allow vapor to pass through, greatly reducing the risk of leaks.

*Many cartridges currently in the market require adjustments to accommodate oils with different viscosities, but our patented technology eliminates this need and allows for seamless use with various oil types.*

## Superior Heating Element

Due to quartz's crystalline structure, it naturally conducts heat while using less energy compared to other atomizers on the market.

*Since quartz has equally-sized pores, it allows the atomizer to heat up and vaporize the oil more evenly with less energy, resulting in a smoother vaping experience without any burnt hits.*

Black Mouthpiece

White Mouthpiece



\* PatentNo: US 10,701,977

## HOW TO ORDER & GET PRICING

Please email:

[SUPPORT@BEARROOTZ.COM](mailto:SUPPORT@BEARROOTZ.COM)

Ask for our individual packets to learn more about our products!

### DETAILS

- Full Customization Available
- Patented Quartz Atomizer Technology
- Universal 510-Thread Base
- Stainless Steel Center Post

### DESIGN OPTIONS

- **TANK:** Glass
- **CENTER POST:** Stainless Steel
- **BODY:** Custom
- **TIPS:** Bullet (Screw-On)

### SIZES

0.3mL

0.5mL

1.0mL

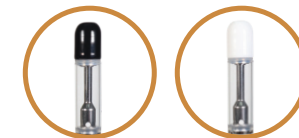

BEARROOTZ.COM

# QUARTZ AIO CUSTOMIZATIONS TAO S (DQ1101S)

## DETAILS

- Patented Quartz Atomizer Technology
- Stainless Steel Center Post
- Rechargeable
- 1.4ohm Resistance
- Micro-USB
- Inhale Activated

## TANK

GLASS

## SIZES

0.3mL

0.5mL

1.0mL

## TIPS (Press-On)

Shape:

DUCKBILL

Material:

CERAMIC

TIP OPTIONS:  
Black or White  
Ceramic Duckbill



## PACKAGING OPTIONS

### INDIVIDUAL OPTIONS

- No Window
- Window
- No Hanger
- Hanger
- Non-CR
- CR

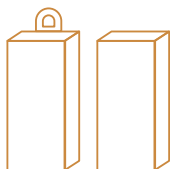

### MASTER DISPLAY

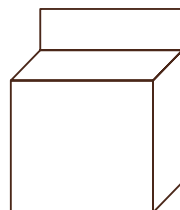

AIO boxes are fully customizable to your brand. We can print as many colors as you would like, but keep in mind, the more colors you print, the higher the cost.

## AIO DESIGN OPTIONS

Options can be combined.

Logo on Body (1 Color)	+ \$0.06
Logo on Body (2 Colors)	+ \$0.11
Logo on Glass (1 Color)	+ \$0.06
Logo on Glass (2 Color)	+ \$0.11
Custom Body Color	+ \$0.11
Custom Color Mouthpiece	+ \$0.11
Cannabis State Warning Symbol on Glass	+ \$0.06-\$0.14

CUSTOM AREAS

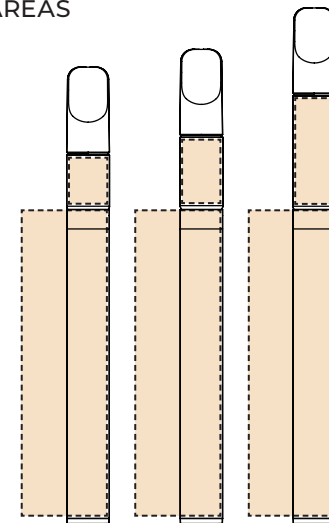

## MINIMUM ORDER QUANTITY

AIO	3,000
INDIVIDUAL BOXES	Varies
MASTER DISPLAY BOXES	Varies

Higher quantities purchased may result in price breaks. Please speak to a sales agent for pricing details.

# TAO S (DQ1101S) QUARTZ AIO



*Same oil, better flavor, happier customers!*

Quartz Atomizer Technology is the next step in the cartridge evolution, it's the most modern & flavorful way to vape! Our Quartz Cartridges feature our patented quartz atomizer and filter system that enhances oil flavor while reducing leakage and damage. Our stock Quartz Cartridges can also be fully customized to suit your branding needs.

## The Best Flavor Profile on the Market

Thanks to the natural properties of quartz, quartz atomizers provide superior flavor and consistent vapor production from the very first puff to the last.

*Atomizers made of non-quartz materials tend to wear down faster, releasing particles into the vapor and altering the oils' natural flavor.*

## Handles Almost All Ranges of Viscosity

Our patented microporous filtering technology allows processors to use a single cartridge style for multiple oil types. Our quartz filters are designed to only allow vapor to pass through, greatly reducing the risk of leaks.

*Many cartridges currently in the market require adjustments to accommodate oils with different viscosities, but our patented technology eliminates this need and allows for seamless use with various oil types.*

## Superior Heating Element

Due to quartz's crystalline structure, it naturally conducts heat while using less energy compared to other atomizers on the market.

*Since quartz has equally-sized pores, it allows the atomizer to heat up and vaporize the oil more evenly with less energy, resulting in a smoother vaping experience without any burnt hits.*

Black Mouthpiece

White Mouthpiece



\* PatentNo: US 10,701,977

## HOW TO ORDER & GET PRICING

Please email:

[SUPPORT@BEARROOTZ.COM](mailto:SUPPORT@BEARROOTZ.COM)

Ask for our individual packets to learn more about our products!

### DETAILS

- Full Customization Available
- Patented Quartz Atomizer Technology
- Universal 510-Thread Base
- Stainless Steel Center Post

### DESIGN OPTIONS

- **TANK:** Glass
- **CENTER POST:** Stainless Steel
- **BODY:** Custom
- **TIPS:** Flat Duckbill (Press-On)

### SIZES

0.3mL

0.5mL

1.0mL



BEARROOTZ.COM

## DIAGRAMS: STELLA SERIES DQ11 & DQ101S QUARTZ ALL-IN-ONE

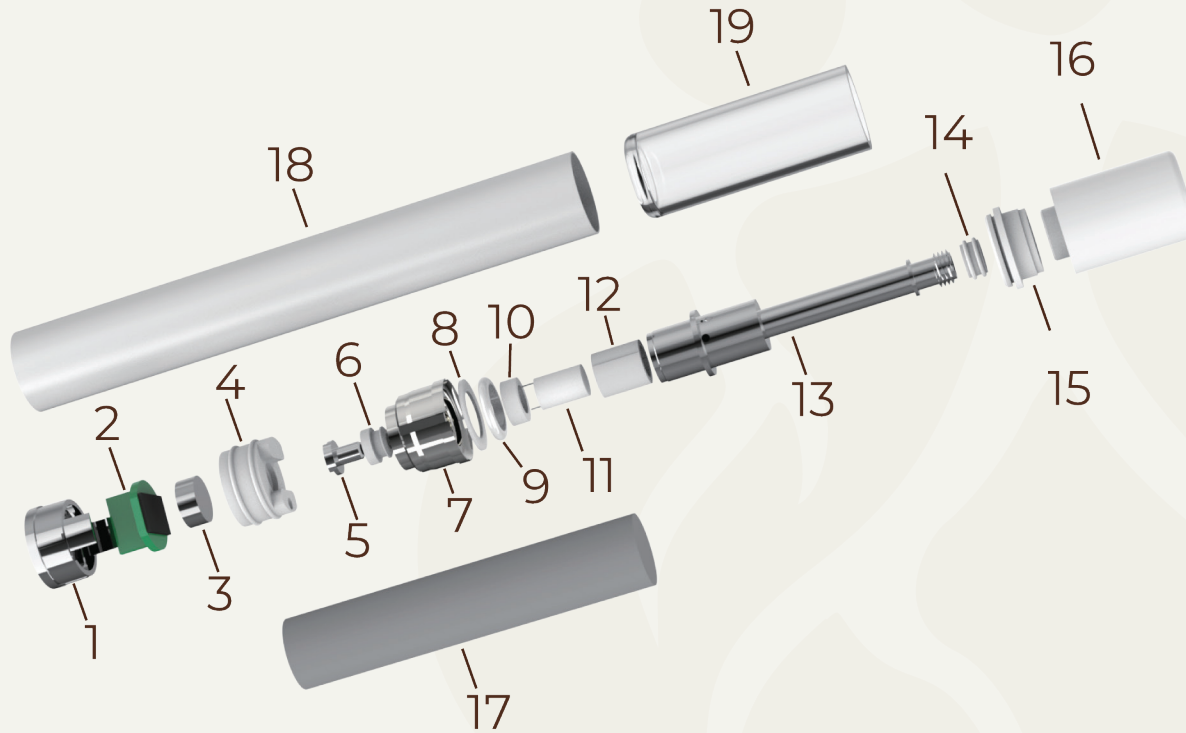

DQ11 DQ101S

1	USB Tail Cap	6	Electrode Pin Gasket	11	Quartz Disc	16	Mouthpiece
2	Control Board	7	510 Base Threading	12	Non-Woven Fabric/Cotton	17	Battery
3	Sensor	8	O-Type Gasket	13	Stainless Steel Center Post	18	510 Battery
4	Silicone Gasket	9	O-Ring	14	Oil Resistant Silicone Piece	19	Glass Housing
5	Electrode Pin	10	Plastic Spacer	15	Silicone Gasket		

Our **Quartz ALL-IN-ONE** is the next step in the disposable evolution by using our **Quartz Atomizer Technology** to provide the most modern and flavorful way to vape. Available in **0.3, 0.5, & 1mL**, our patented quartz filtering and the heating system eliminate most leaking and due to the natural properties of quartz drastically reduce the wear other material atomizers experience during use. The end result is a more flavorful vapor and a happier customer! Included is a **base mouthpiece of a screw-on black ceramic bullet or Press-on flat duckbill.**